

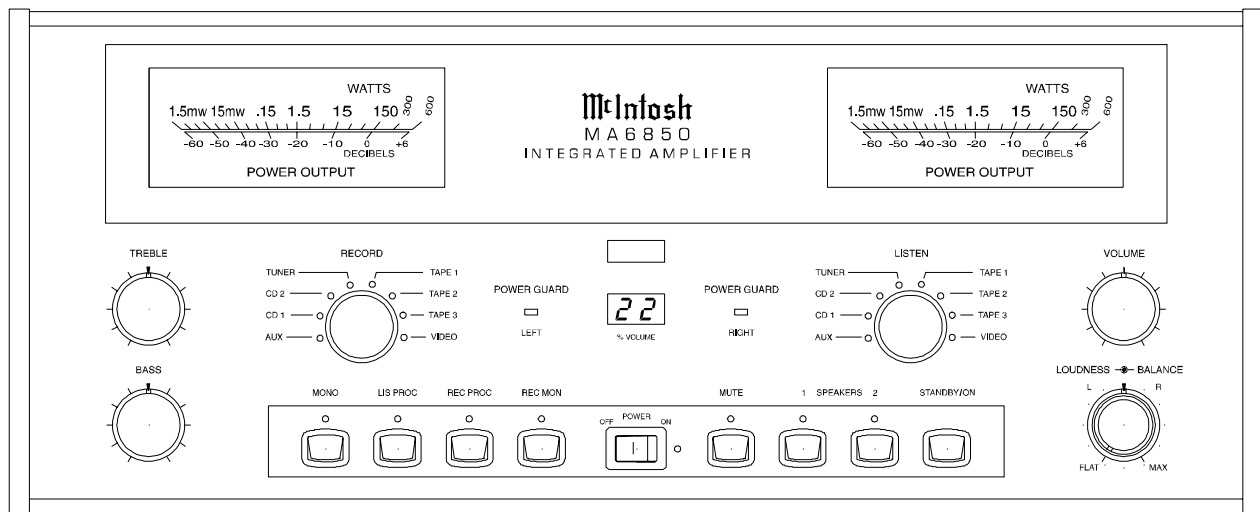

MA6850 Integrated Amplifier



MA6850



Thank You, Please Take A Moment, Customer Service and Table of Contents

Thank You

For your decision to own this McIntosh MA6850 Integrated Amplifier ranks you at the very top among discriminating music listeners. You now have "The Best." The McIntosh dedication to "Quality," is assurance that you will receive many years of musical enjoyment from this unit.

Please take a short time to read the information in this manual. We want you to be as familiar as possible with all the features and functions of your new McIntosh MA6850. This will ensure that you receive all the performance benefits this equipment can offer you, and that it will become a highly valued part of your home entertainment system.

Please Take A Moment

The serial number, purchase date and McIntosh dealer name are important to you for possible insurance claim or future service. The serial number is located on the rear panel of the equipment. The spaces below have been provided for you to record that information:

Serial Number: _____

Purchase Date: _____

Dealer Name: _____

Customer Service

If at any time you have questions about your McIntosh MA6850 Integrated Amplifier, contact your McIntosh dealer. Your dealer is familiar with your McIntosh equipment as well as other brands that may be included in your system and is best qualified to help you.

If it is determined that your MA6850 is in need of repair, you can return it to your dealer or you can return it to McIntosh Laboratory. Contact the McIntosh Repair Department for assistance at,

McIntosh Laboratory, Inc.
2 Chambers Street
Binghamton, New York 13903
Phone: 607-723-3512
FAX: 607-724-0549

Table of Contents

Thank You	2
Please Take a Moment	2
Customer Service	2
Table of Contents	2
Safety Instructions	3
Introduction	4
Performance Features	4
Installation	5
Rear Panel Connections	6
How to Connect	7
How to Connect with a MVS-3 and a Second Room	8
Front Panel Displays and Controls	9
How to Operate	10
HR-033 Push-Buttons	12
How to Operate by Remote Control	13
Specifications	14
Packing Instruction	15

NOTES:

1. *Connecting Cables and Connectors are available from the McIntosh Parts Department:
Data and Power Control Cable Part No. 170-202
Six foot, shielded 2 conductor, with 1/8 inch stereo mini phone plugs on each end.*
2. *For additional connection information, refer to the owner's manual(s) for any component(s) connected to the MA6850 Integrated Amplifier.*
3. *There is a built-in turn on delay which will mute the speaker outputs for approximately two seconds when the amplifier is turned on.*
4. *It is very important that loudspeaker cables of adequate size be used in your music system, to ensure that there will be no power loss or heating. Cable size is specified in Gauge numbers or AWG, (American Wire Gauge). The smaller the Gauge number, the larger the wire size:
If your loudspeaker cables are 25 feet (7.62m) or less, use at least 18 Gauge (AWG) wire size or larger.
If your loudspeaker cables are 50 feet (38.1m) or less, use at least 16 Gauge (AWG) wire size or larger.
If your loudspeaker cables are 100 feet (76.2m) or less, use at least 14 Gauge (AWG) wire size or larger.*

IMPORTANT SAFETY INSTRUCTIONS!

PLEASE READ THEM BEFORE OPERATING THIS EQUIPMENT.



WARNING SHOCK HAZARD - DO NOT OPEN.



AVIS RISQUE DE CHOC - NE PAS OUVRIR.



NO USER-SERVICEABLE PARTS INSIDE. REFER SERVICING TO QUALIFIED PERSONNEL



General:

1. Read all the safety and operating instructions, contained in this owner's manual, before operating this equipment.
2. Retain this owner's manual for future reference about safety and operating instructions.
3. Adhere to all warnings and operating instructions.
4. Follow all operating and use instructions.
5. **Warning: To reduce risk of fire or electrical shock, do not expose this equipment to rain or moisture. This unit is capable of producing high sound pressure levels. Continued exposure to high sound pressure levels can cause permanent hearing impairment or loss. User caution is advised and ear protection is recommended when playing at high volumes.**
6. **Caution: to prevent electrical shock do not use this (polarized) plug with an extension cord, receptacle or other outlet unless the blades can be fully inserted to prevent blade exposure.**
Attention: pour prevenir les chocs electriques pas utiliser cette fiche polarisee avec un prolongateur, une prise de courant ou un autre sortie de courant, sauf si les lames peuvent etre inserees afond ans en laisser aucune partie a decouvert.
7. For added protection for this product during a lightning storm, or when it is left unattended and unused for long periods of time, unplug it from the wall outlet and disconnect the antenna or cable system. This will prevent damage to the product due to lightning or power line surges.

8. Do not use attachments not recommended in this owner's manual as they may cause hazards.

Installation:

9. Locate the equipment for proper ventilation. For example, the equipment should not be placed on a bed, sofa, rug, or similar surface that may block ventilation openings; or, placed in a built-in installation, such as a bookcase or cabinet, that may impede the flow of air through the ventilation openings.
10. Locate the equipment away from heat sources such as radiators, heat registers, stoves, or other appliance (including amplifiers) that produce heat.
11. Mount the equipment in a wall or cabinet only as described in this owner's manual
12. Do not use this equipment near water; for example, near a bathtub, washbowl, kitchen sink, laundry tub, in a wet basement or near a swimming pool, etc.
13. Do not place this product on an unstable cart, stand, tripod, bracket, or table. The equipment may fall, causing serious injury to a person, and serious damage to the product.

Connection:

14. Connect this equipment only to the type of AC power source as marked on the unit.
15. Route AC power cords so that they are not likely to be walked on or pinched by items placed upon or against them, paying particular attention to cords at plugs, convenience receptacles, and the point where they exit from the instrument.
16. Do not defeat the inherent design features of the polarized plug. Non-polarized line cord adapters will defeat the safety provided by the polarized AC plug. If the plug should fail to fit, contact your electrician to replace your obsolete outlet. Do not defeat the safety purpose of the grounding-type plug.
17. Do not overload wall outlets, extension cords or integral convenience receptacles as this can result in a risk of fire or electric shock.

Care of Equipment:

18. Clean the instrument by dusting with a dry cloth. Unplug this equipment from the wall outlet and clean the panel with a cloth moistened with a window cleaner. Do not use liquid cleaners or aerosol cleaners.
19. Do not permit objects of any kind to be pushed and/or fall into the equipment through enclosure openings.



Never spill liquids into the equipment through enclosure openings.

20. Unplug the power cord from the AC power outlet when left unused for a long period of time.

Repair of Equipment:

21. Unplug this equipment from the wall outlet and refer servicing to a qualified service personnel under the following conditions:
 - A. The AC power cord or the plug has been damaged.
 - B. Objects have fallen, or liquid has been spilled into the equipment.
 - C. The equipment has been exposed to rain or water.
 - D. The equipment does not operate normally by following the operating instructions contained within this owner's manual. Adjust only those controls that are covered by the operating instructions, as an improper adjustment of other controls may result in damage and will often require extensive work by a qualified technician to restore the product to its normal operation.
 - E. The equipment has been dropped or damaged in any way.
 - F. The equipment exhibits a distinct change in performance - this indicates a need for service.
22. Do not attempt to service beyond that described in the operating instructions. All other service should be referred to qualified service personnel.
23. When replacement parts are required, be sure the service technician has used replacement parts specified by McIntosh or have the same characteristics as the original part. Unauthorized substitutions may result in fire, electric shock, or other hazards.
24. Upon completion of any service or repairs to this product, ask the service technician to perform safety checks to determine that the product is in proper operating condition.

Introduction

The remote controlled MA6850 is a sophisticated, yet easy to operate Integrated Amplifier that will provide the superior fidelity music reproduction that is traditional from McIntosh. It includes a wide range of convenient operating functions to enhance your listening enjoyment. The classic McIntosh MA6850 will perfectly complement a pair of McIntosh Loudspeakers for a stereo system of incomparable performance and style.

Performance Features

- **150 Watt per Channel Integrated Amplifier**

The MA6850 combines 150 watt per channel power amplifier with McIntosh Autoformers and a sophisticated control center in one compact unit.

- **Power Guard with Sentry Monitor**

Patented McIntosh Power Guard circuit that prevents the amplifier from being overdriven into clipping with its harsh distorted sound that can also damage your valuable loudspeakers. Sentry Monitor power output stage protection circuits ensure the MA6850 will have a long and trouble free operating life.

- **Illuminated Peak Responding Output Meters**

Output meters respond to 95% of full scale reading with a single cycle of a 2KHz tone burst to indicate output power with high accuracy.

- **Output and Speaker Switching**

Front panel Speakers push-buttons control two pairs of speakers when the optional SCR3 switching relay is added.

- **Listen and Record Circuitry**

Separate Record and Listen circuits allow you to record one program source while listening to another. Separate signal processor loops are provided for both the Listen and Record circuits.

- **Electronic Input Switching**

Digital Logic integrated circuits drive Electromagnetic switches on all eight inputs and operating functions for reliable, noiseless, distortion free switching

- **Tone Control Bypass**

At the flat settings the Bass and Treble control circuit elements are removed from the Listen signal path.

- **Active Loudness Circuitry**

A continuously variable active Loudness control allows any degree of loudness compensation. All Loudness circuit elements are removed from the signal path in the flat setting.

Installation

The MA6850 can be placed upright on a table or shelf, standing on its four feet. It also can be custom installed in a piece of furniture or cabinet of your choice. The required panel cutout, ventilation cutout and unit dimensions are shown.

Always provide adequate ventilation for your MA6850. Cool operation ensures the longest possible operating life for any electronic instrument. Do not install the MA6850 directly above a heat generating component such as a high powered amplifier. If all the components are installed in a single cabinet, a quiet running ventilation fan can be a definite asset in maintaining all the system components at the coolest possible operating temperature.

A custom cabinet installation should provide the following minimum spacing dimensions for cool operation. Allow at least 2 inches (5.1 cm) above the top and 1 inch (2.54 cm) on each side of the amplifier, so that airflow is not obstructed. Allow 21 inches (53.3 cm) depth behind the mounting panel, which includes clearance for connectors. Allow 1-1/8 inches (2.9 cm) in front of the mounting panel for knob clearance. Be sure to cut out a ventilation hole in the mounting shelf according to the dimensions in the drawing.

NOTE: In Europe, if the MA6850 is custom mounted, an additional ventilation opening of 1-1/2 inch (3.8 cm) in height, running the full width of the front panel, needs to be directly above the front top of the MA6850.

Front View of an MA6850 custom installed

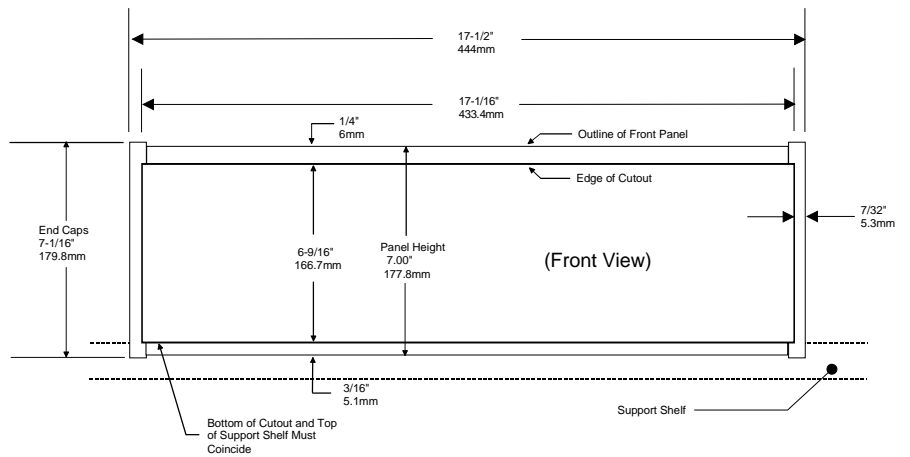

Side View of an MA6850 custom installed

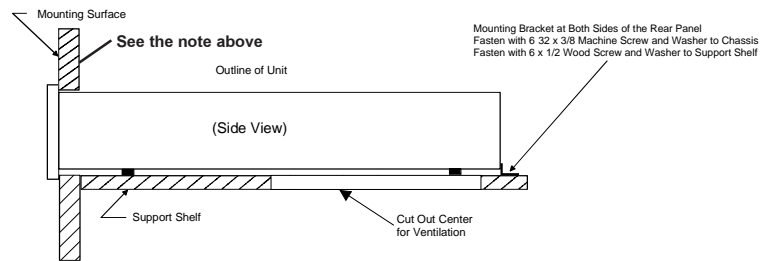

Bottom View of an MA6850 custom installed

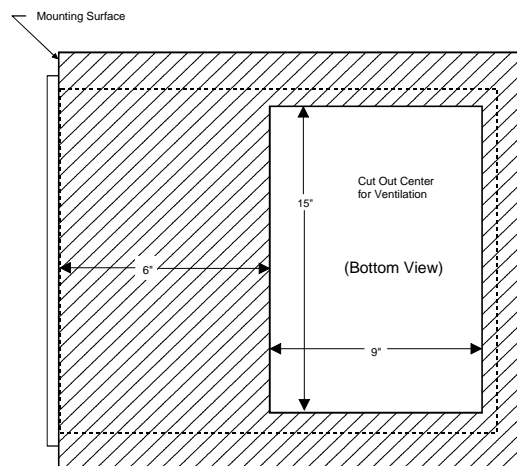



MA6850 Rear Panel Connections

PREAMP OUT send signals to an external power amp inputs, POWER AMP IN jacks accept signals from an external preamplifier or signal source, EXT-IN PWR AMP INPUT switch disconnects the power amplifier from the built-in preamplifier

RECORD TAPE 1, 2 and 3 OUTPUTS supply record signals for tape recorders

VIDEO, inputs for audio signals from VCR, TV, LD or the optional MVS-3 A/V Selector

DATA PORTS send signals to compatible source components to allow you to remotely control them

Connect the MA6850 power cord to a live AC outlet. Refer to information on the back panel to determine the correct voltage

LISTEN PROCESSOR FROM and TO jacks for a Listen signal processor

RECORD PROCESSOR FROM and TO jacks for a Record signal processor

High Level Inputs accept signals from the output of a TUNER, CD 1 & 2, TAPE 1, 2 & 3 and AUX

The HOME Data Port is for use with the optional HC-1 Home Controller

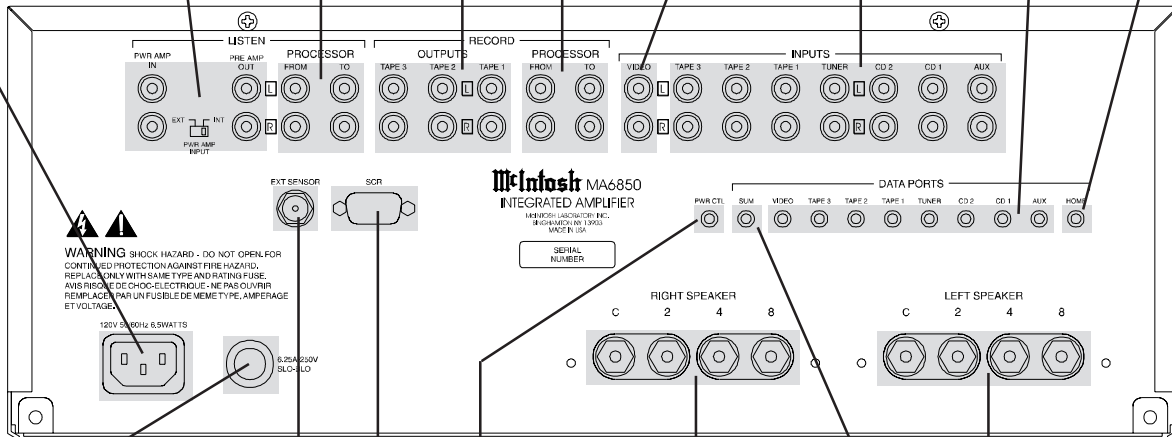

Fuse holder, refer to information on the back panel to determine the correct fuse size and rating.

The EXT (external) Sensor for a McIntosh Keypad or IR sensor.

SCR for the optional McIntosh Speaker Control Relay.

POWER CONTROL Output sends a turn-on signal to a McIntosh Component

SPEAKERS allows one pair of speakers to be connected

SUM Data port allows connection to a McIntosh Remote Control Translator

SPEAKERS allows one pair of speakers to be connected

How to Connect the MA6850

1. Connect the MA6850 power cord to a live AC outlet.
2. Connect the loudspeaker cables to the appropriate terminals for your loudspeakers, being careful to observe the correct polarities. Output impedance connections of 2 ohms, 4 ohms and 8 ohms are provided. If the impedance of your loudspeakers is rated at other than the listed impedance connections, use the nearest lower connection.

NOTE: To prevent the possibility of user contact with potentially dangerous voltages, install the protective cover(s) over the loudspeaker output terminals after the loudspeaker cables have been connected. The covers and cover mounting screws are located in an accessory package that is enclosed in the amplifier shipping carton. There are two types of screws in the package. Install the protective covers with the Phillips, 6-32 by 5/16 inch self tapping screws. The other screws are No. 6 by 1/2 inch wood screws used to secure the amplifier custom mounting brackets to a shelf.

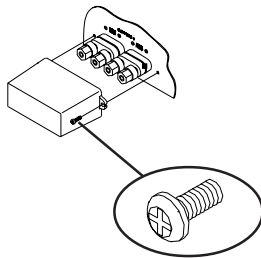

3. Connect a cable from the TAPE 1 OUTPUTS to the Record Inputs of a tape recorder and the TAPE 1 INPUTS to a tape recorder Outputs. Connect a second tape in the same manner to the Tape 2 inputs and outputs.
4. Connect cables from a McIntosh CD Player to the CD1 INPUTS. Connect a second CD Player to the CD-2 INPUTS. Connect a McIntosh tuner to the TUNER INPUTS.
5. Connect a cable from the POWER CONTROL jack to the Power Control In on a McIntosh component or Power Controller.
6. Connect a cable(s) from the DATA PORTS to the components that are to be controlled by the MA6850.

NOTE: If a Signal Processor is used in either the Record or Listen channels, connect cables from the Signal Processor Outputs to the Processor From jacks, and the Signal Processor Inputs to the Processor to jacks. Activate the signal process circuits as needed with the front panel Lis Proc or Rec Proc push-buttons.

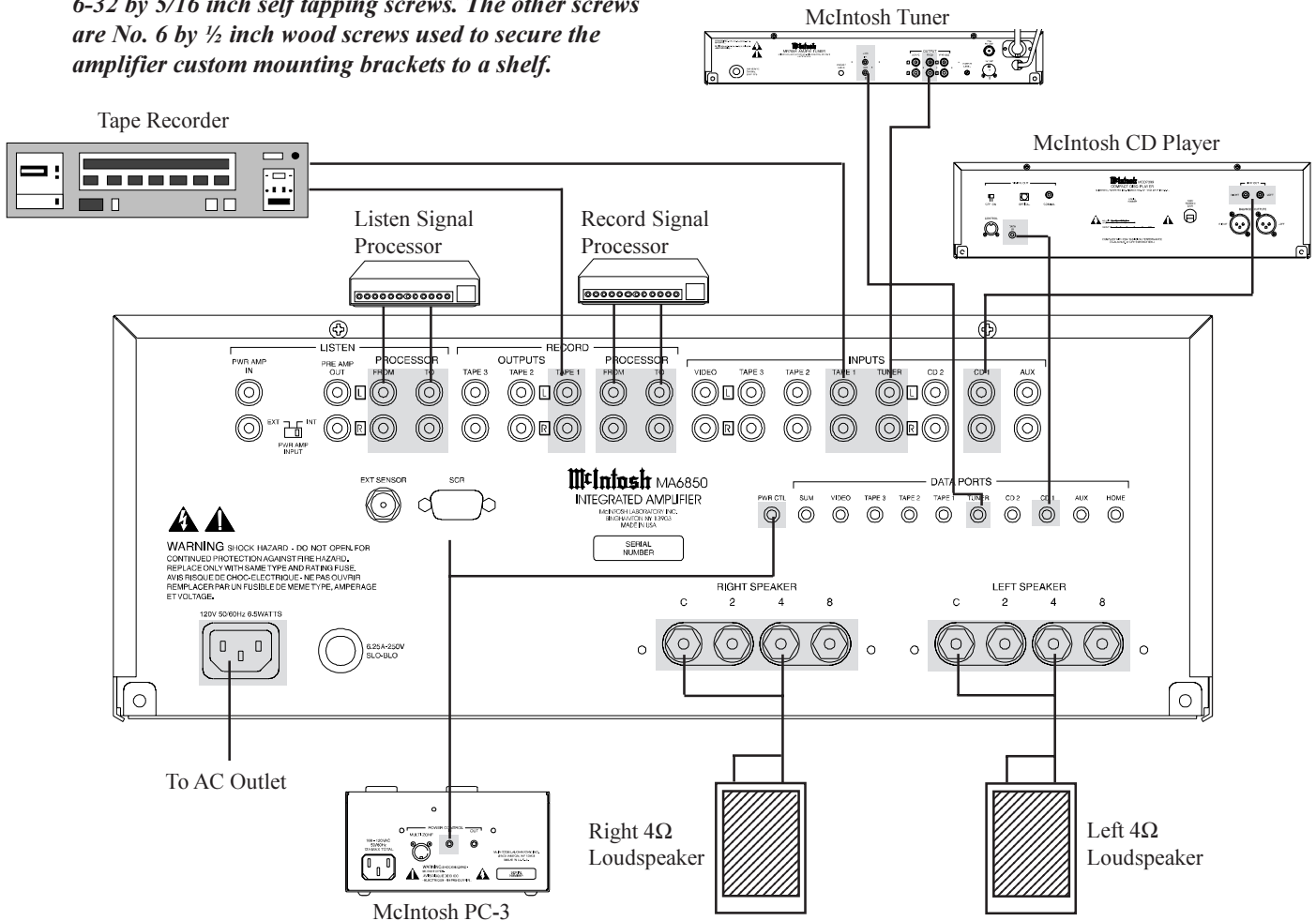



How to Connect the MA6850 with a MVS-3 and a Second Room

How to Connect the MA6850 with a MVS-3 and a Second Room

1. Connect the MVS-3 power cord to a Switched outlet on a McIntosh PC-3 Power Controller.
2. Connect a Data cable from the MA6850 Video Data Port to the MVS-3 Data In jack.
3. Connect the MVS-3 Control Center Audio Outputs to the MA6850 Video Inputs.
4. Connect a McIntosh LD Player audio outputs to the MVS-3 LV Audio Inputs and the Data Out to the MVS-3 LV Data Port.
5. Connect other video source components in a similar manor and refer to the MVS-3 Owners Manual for Video Connections.
6. Connect an SCR-3 Switching Relay cable to the MA6850 SCR jack and the MA6850 Speaker outputs to the SCR-3 Power Amplifier terminals.
7. Connect cables from the main area loudspeakers to the SCR-3 Speaker 1 terminals and cables from the second room loudspeakers to the Speaker 2 terminals.
8. Connect a coax cable (RG6 or RG59/U) from the MA6850 EXT Sensor jack to a McIntosh remote sensor in the second room.

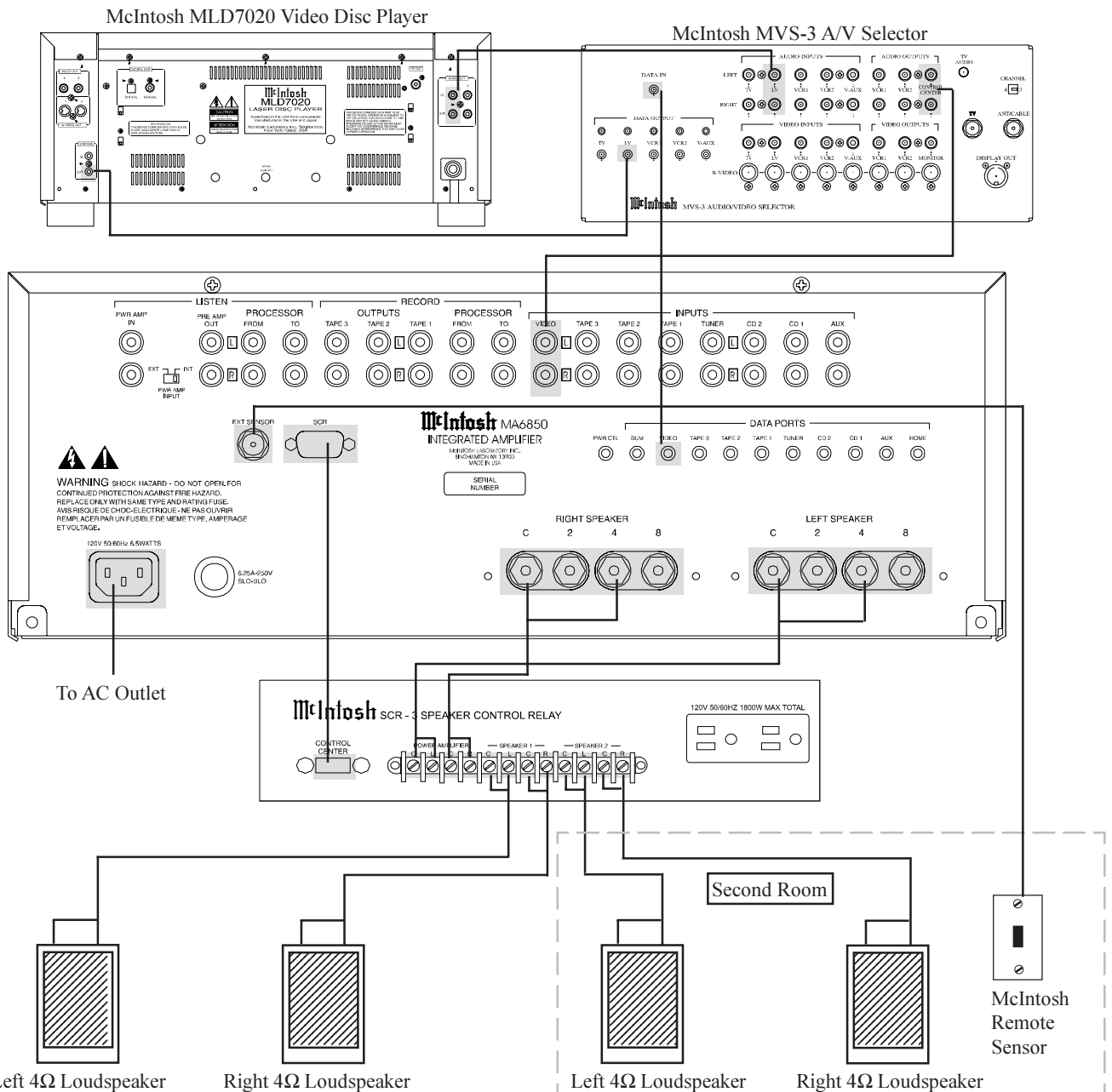

MA6850 Front Panel Displays and Controls

MA6850 Front Panel Displays and Controls

METER indicate power output of the left amplifier channel

METER indicate power output of the right amplifier channel

POWER GUARD LED's light when the amplifier channel Power Guard Circuit activates

POWER GUARD LED's light when the amplifier channel Power Guard Circuit activates

IR (Infra Red) sensor accepts IR signals directly from an HR033 Remote Control

TREBLE control provides 12dB boost or cut with a flat center position

Indicates volume level in % from 1 to 99

Stand-by On Indicator

Volume control allows you to adjust the listening level at the Pre Amp and Speakers outputs

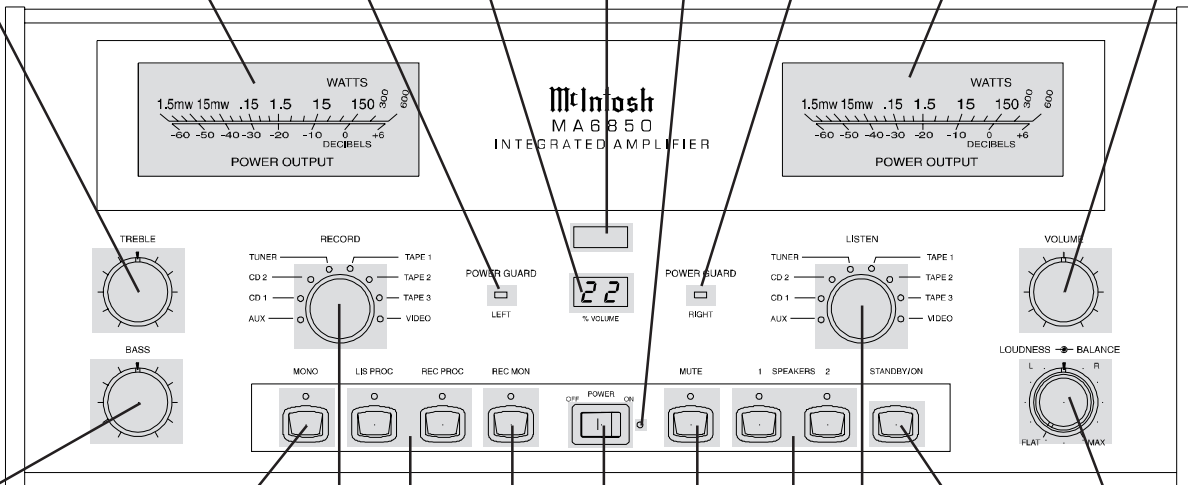

BASS control provides 12dB boost or cut with a flat center position

RECORD selector selects which of the eight input program signal sources will appear at the Record Outputs

POWER switch turns all AC power completely ON or OFF

MUTE push-button mutes audio at the Preamp and Speaker Outputs

STANDBY/ON push-button turns the MA6850 ON, or OFF (Standby)

Listen selector selects which of the eight input signal sources will appear at the Pre Amp and Speakers outputs

MONO push-button combines the left and right channels for mono operation at the Speakers and Pre Amp outputs. The Record Outputs are not affected

Press to activate the Listen and Record processor circuits

Press Rec Mon (Record Monitor) to listen to the signal being sent to the Record Outputs

Press to select either pair of loudspeakers or both pairs at the same time when the optional SCR-3 Speaker Control Relay is added

LOUDNESS control (smaller inner knob) provides adjustable frequency response contoured to compensate for the behavior of the human ear at softer listening levels. The BALANCE control (large outer knob) allows you to adjust the relative volume balance between channels



How to Operate the MA6850

Power On

Press the Power Switch to on. The red LED to the right of the switch lights to indicate the MA6850 is in standby mode. For normal operation, turn the MA6850 on and off with the Standby/On push-button. If the amplifier is not going to be used for an extended time, turn off all AC power with Power Switch. Refer to Figure 1.

NOTE: You may also turn on the MA6850 using the HR033 Remote Control.

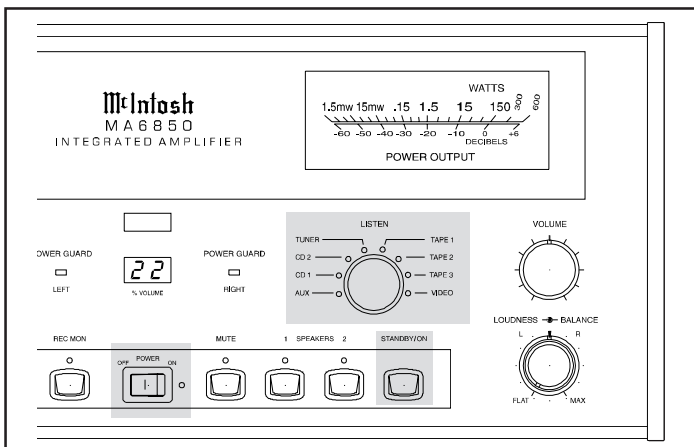

Figure 1

Source Selection

Select the desired listening source with the LISTEN Switch.

Volume Control

Adjust the VOLUME control for the desired listening level.

Balance Control

Adjust the BALANCE control as needed to achieve approximately equal listening volume levels in each loudspeaker. Turn the BALANCE to the Left to emphasize the left channel by reducing the level of the right channel. Turn the BALANCE to the right to emphasize the right channel by reducing the level of the left channel.

Bass and Treble Controls

Adjust the BASS and TREBLE controls to suit your listening preferences. The bass or treble intensity can be increased with clockwise rotation and decreased with counterclockwise rotation. All tone control circuit elements are

removed from the signal path when the controls are in the center or flat position.

Loudness Control

After first setting the desired listening volume, rotate the LOUDNESS control clockwise to increase the intensity of the bass according to your listening preference. When the LOUDNESS control is in the fully counter clockwise or flat position, all loudness circuit elements are removed from the signal path.

Mono

Press the MONO push-button to combine left and right stereo signals to mono at the PRE-AMP OUTPUTS and Speaker Outputs.

Mute

Press the MUTE push-button to mute audio at the Preamp and Speaker Outputs.

Listen Processor

Press the front panel Lis Proc (Listen Processor) push-button to select the signal processor that will affect the listen channels. The normal listen signal will be sent out to the Processor to be modified and then received back into the listen channels. For example, a processor in the listen channels, such as an equalizer, can be used to modify the sound that is heard in the loudspeakers to satisfy a specific listener's needs.

Record Processor

Press the Rec Proc (Record Processor) push-button to select the processor that will affect all three record outputs. The record signals will be sent out to the processor to be modified and then received back to appear at the record outputs. The type of processor used can modify the record signals to make an improved quality recording. Any processing used to modify the record output signal will not affect the listen signals. To listen to the record signals at any time, press the Rec Mon push-button.

Note: If a processor is connected and selected, the processor must be on and operating or in bypass mode for signal to pass through the system. If a processor is selected and no processor is connected, no signal will pass through.

Speakers 1 and 2

With the optional SCR-3 Speaker Control Relay connected, select either one of two pairs of loudspeakers or both pairs at the same time.

Reset of Microprocessors

In the event that the controls of the MA6850 stop functioning push the POWER switch OFF and wait about two minutes, then push the POWER switch ON followed by pushing the STANDBY/ON push button. This will reset the MA6850 microprocessors and the Amplifier should be functioning normally.

NOTE: The above condition is usually caused by either interruptions in AC power and/or major changes in voltage.

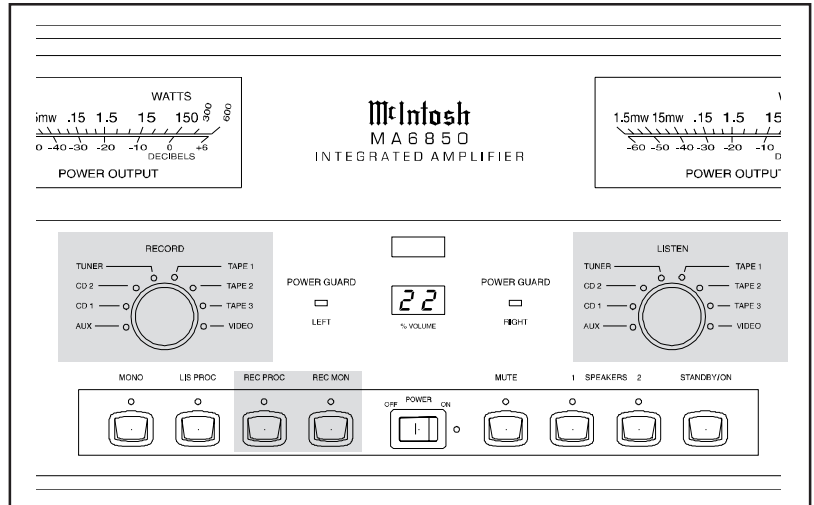

Figure 2

How To Make A Tape Recording

The separate RECORD and LISTEN switches allow you to make a tape recording from one program source while listening to another. You can also listen (monitor) to the recorded signal off the tape, a fraction of a second later, during recording when a three head tape recorder is used. Refer to Figure 2

1. Select the desired program source to record with the front panel RECORD selector switch.
2. If a signal processor is connected for use in the record channels, press the Rec Proc push-button to select the record processor.
3. Adjust the record level using the tape recorder volume control.
4. To listen to the tape playback of the program source just recorded, turn the LISTEN switch to the desired input.
5. Press the Rec Mon (Record Monitor) at any time to listen to the program signals that are being sent to the Record Outputs.

NOTE: The MA6850 RECORD OUTPUTS are not affected by the VOLUME or BALANCE controls. To listen to a different program source while recording, turn the LISTEN switch to the desired source. The recording process will not be affected and will continue.

How to Read the Power Output Meters

The MA6850 Power Output meters are peak responding and accurately indicate the actual wattage delivered to the loudspeakers by responding to the combination of current and voltage output. The power outputs for the meter scale indications between the numerical markings (high-lighted in gray) are shown below.

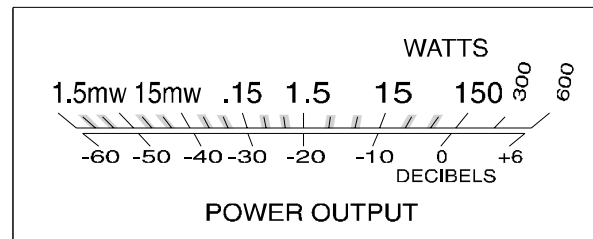

Meter Reading	Actual Power Output	Meter Reading	Actual Power Output
150	150 Watts	.15	0.15 Watts
-	60 Watts	-	0.06 Watts
-	30 Watts	-	0.03 Watts
15	15 Watts	15mw	15 Milliwatts
-	6 Watts	-	6 Milliwatts
-	3 Watts	-	3 Milliwatts
1.5	1.5 Watts	1.5mw	1.5 Milliwatts
-	0.6 Watts	-	0.6 Milliwatts
-	0.3 Watts	-	0.3 Milliwatts



HR033 Push-Buttons

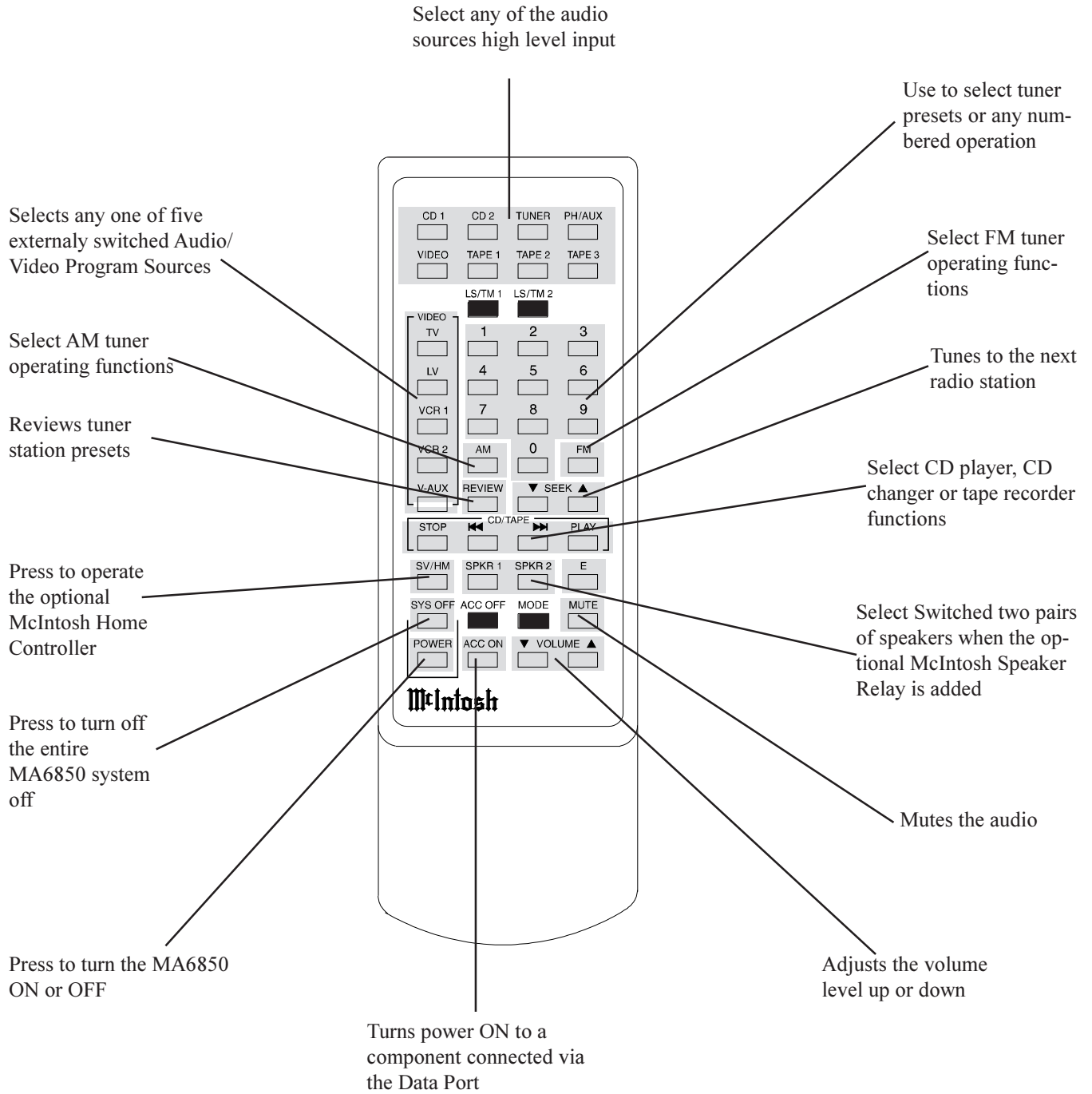

Note: The HR033 Remote Control push-buttons that are shown in black only work with other McIntosh Products

How to Operate HR033

Mute

Press MUTE to mute the LISTEN signals at the PREAMP and SPEAKER Outputs. The MUTE LED above the push-button will flash on and off to indicate that Mute is active. Press MUTE a second time to unmute audio.

Mono

Press the MONO push-button to combine left and right stereo signals to mono at the PREAMP and SPEAKER Outputs.

Audio

Press any of the eight Audio push-buttons to select a LISTEN program source.

Video/Audio Selection

When the optional McIntosh MVS Audio/Video Selector is added, first press VIDEO, and then the desired push-button to select any of the five A/V sources connected to the MVS.

CD/Tape

Use these push-buttons to operate a CD player, CD changer or tape recorder, when the component is connected to the MA6850 with a McIntosh RCT Translator.

Numbered Push-buttons

Press push-buttons 0 through 9 to access tuner station presets, CD tracks/discs, or operate a McIntosh Home Controller.

Disc and Track

Use the DISC and TRACK push-buttons when a CD player or changer is being used.

Tuner Push-buttons

Use with a McIntosh tuner. Select AM or FM broadcast band. Press and release SEEK Up or Down to move from station to station. Press and hold a SEEK push-button to move continuously from station to station. Press REVIEW to start the automatic brief audition of each of the presets stored in the tuner memory. Press REVIEW a second time to stop on a station preset and exit the Review process.

Volume

Press the Up or Down VOLUME push-button to raise or lower the listening volume level, the Record Outputs are not affected.

Speaker Selection

Press SPKR 1 or SPKR 2 push-buttons either separately or together, to control the optional McIntosh Speaker Control Relay which can switch two pairs of speakers on and off, separately or together.

Home

When the optional HC-1 Home Controller is added to the MA6850 system, press the SV/HM (Home) push-button to select the HC-1. Within 5 seconds press one of the numbered push-buttons to activate a desired relay in the HC-1.

Acc On

Press Acc On to turn on a McIntosh Video Disc Player or any accessory component connected using a McIntosh Remote Control Translator.

NOTE: When other brands of components are connected with a McIntosh Remote Control Translator (RCT), refer to the RCT Owner's Manual for further information on alternate HR033 push-button functions.



Specifications

Power Output Per Channel

150 watts into 2, 4 or 8 ohm loads minimum sine wave continuous average power output per channel both channels operating.

Output Load Impedance

2, 4 or 8 ohms

Rated Power Band

20Hz to 20,000Hz

Dynamic Headroom

2.4dB

Frequency Response

+0, -0.5dB from 20Hz to 20,000Hz

Total Harmonic Distortion

0.005% maximum at any power level from 250 milliwatts to rated power per channel from 20Hz to 20,000Hz, all channels operating.

Intermodulation Distortion

0.005% maximum if instantaneous peak output per channel does not exceed twice the rated output with all channels operating for any combination of frequencies from 20Hz to 20,000Hz.

Signal To Noise Ratio

110dB below rated output, Power Amplifier (A-weighted)
100dB below rated output, Preamplifier (A-weighted)

Sensitivity

250mV for 2.5V rated output, Preamplifier inputs
2.5V for rated output, Power Amplifier

Preamplifier Maximum Voltage Output

8V from 20Hz to 20,000Hz

Preamplifier Maximum Input Signal

10V

Damping Factor

Greater than 40

Power Requirements

100 Volts, 50/60Hz at 7.8 amps
110 Volts, 50/60Hz at 7.2 amps
120 Volts, 50/60Hz at 6.5 amps
220 Volts, 50/60Hz at 3.15 amps
230 Volts, 50/60Hz at 3.15 amps
240 Volts, 50/60Hz at 3.15 amps

NOTE: Refer to the rear panel of the MA6850 for the correct voltage

Dimensions

Front Panel: 17 1/2 inches (44.5cm) wide, 7-1/16 inches (17.9cm) high. Depth behind front mounting panel is 20 inches (50.8cm) including clearance for connectors. Panel clearance required in front of mounting panel is 1-1/8 inches (2.9cm).

Weight

70 pounds (31.86Kg) net, 89 pounds (40.4Kg) in shipping carton

Packing Instructions

In the event it is necessary to repack the equipment for shipment, the equipment must be packed exactly as shown below. It is very important that the four plastic feet are attached to the bottom of the equipment. Three #10 x 2-1/4" screws and washers must be used to fasten the unit securely to the bottom pad and wood skid This will ensure the proper equipment location on the bottom pad. Failure to do this will result in shipping damage.

Use the original shipping carton and interior parts only if they are all in good serviceable condition. If a shipping carton or any of the interior part(s) are needed, please call or write Customer Service Department of McIntosh Laboratory. Please see the Part List for the correct part numbers.

Quantity	Part Number	Description
1	033888	Shipping carton only
4	033887	End cap (Foam pad)
1	033697	Inside carton only
1	033725	Top Pad
1	033698	Bottom pad
3	017218	Plastic foot (spacer)
1	033699	Wood skid
3	101169	#10 x 2-1/4" Wood screw
3	104033	#10 x 1-3/4" Wood screw
4	017218	Plastic foot
4	100159	#10-32 x 3/4" Machine screw
4	104083	#10 x 7/16" Flat washer
1	040572	Shipping carton complete with all the above parts

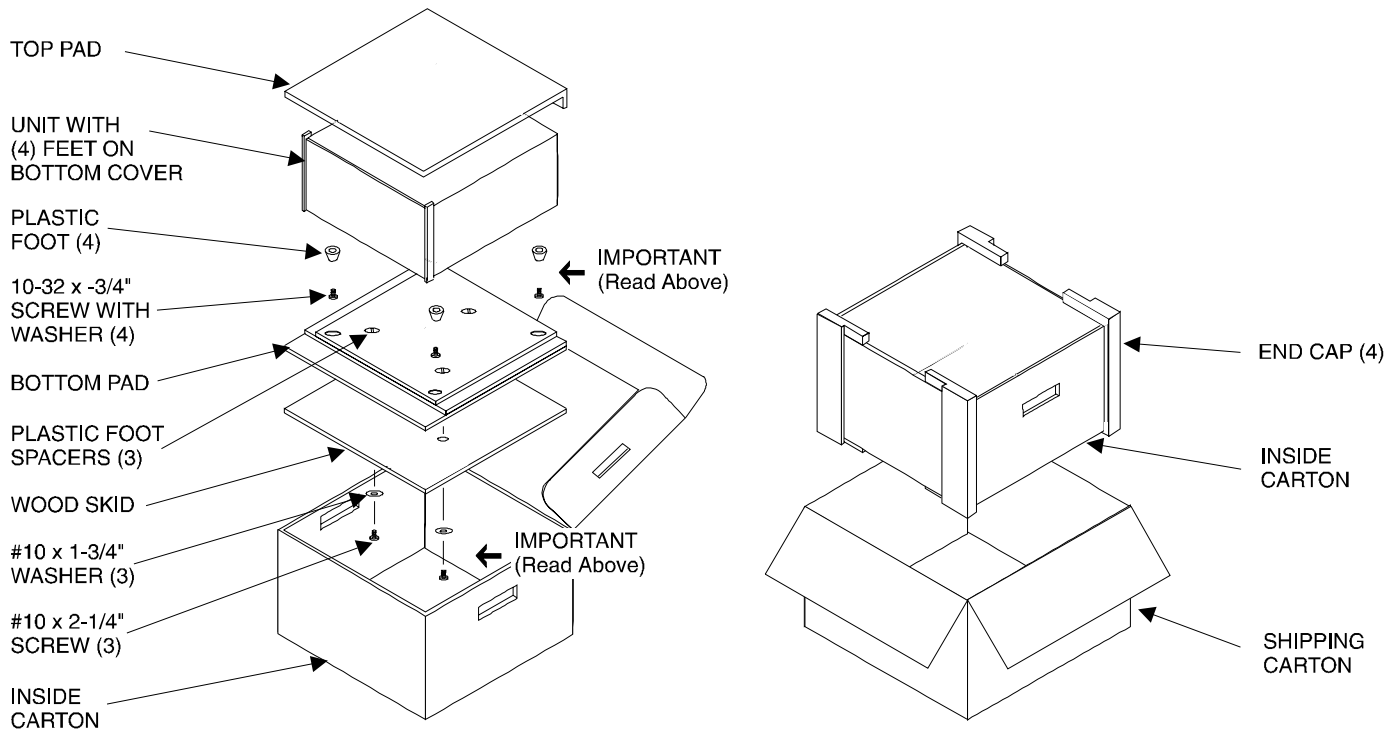

McIntosh[®]

McIntosh Laboratory, Inc.
2 Chambers Street
Binghamton, NY 13903